

## RECEIVER TYPE CR.300.

### GENERAL CHARACTERISTICS.

This receiver provides a high standard of performance for general purpose reception over its very wide frequency range of 15 kc/s to 25 Mc/s, (20,000 to 12 metres). In conjunction with its supply unit it may be operated from most of the sources of supply normally available.

It is of the superheterodyne type and avoids gaps in the frequency range by selecting either of two intermediate frequencies, i.e., 570 kc/s or 98 kc/s according to the signal frequency.

The receiver will give thoroughly satisfactory operation with a single wire aerial not exceeding 700 $\mu$ F in capacity including feeder. The use of a screened down lead will help to avoid strong interference fields in the receiving building itself.

The use of controlled feedback ensures a high order of I.F. selectivity, which is adjustable by switch-control over a wide range of pass-bands.

The salient features of the receiver are briefly listed below.

#### Salient Features.

##### (a) *High Electrical Performance.*

In addition to the flexible selectivity range provided, the receiver sensitivity at low frequencies is adequate for working down to basic radio noise (static, etc.) with the aerial suggested. In spite of the extended frequency range it has been possible to maintain the sensitivity at the higher frequencies to approximate to that of receivers limited to high-frequency reception only.

##### (b) *Self-checking Calibration.*

The Type CR.300/1 receiver includes a 500 kc/s crystal oscillator switched on by a front of panel control, and harmonics of the latter frequency may be introduced into the input circuit of the receiver. As these harmonics coincide with main calibration frequencies on the calibration dial, the calibration may be instantaneously checked to crystal standards of accuracy without the use of external apparatus.

The Type CR.300/2 edition includes a similar crystal operating at 690 kc/s in order to provide harmonic points corresponding to the calling frequencies used for Marine short-wave bands.

##### (c) *Temperature Compensation.*

The first frequency change oscillator is so compensated for thermal drift that this factor becomes negligible within 30 minutes of switching on.

##### (d) *Logging Scale.*

The receiver embodies the calibration and logging arrangements standard for the CR. series of receivers. Operation of the bandchange switch brings into view a scale showing only the frequencies covered by that switch position. Additionally a logging scale provides the operator with facilities for noting the readings of a particular station with a discrimination greatly exceeding that of the absolute calibration scale.

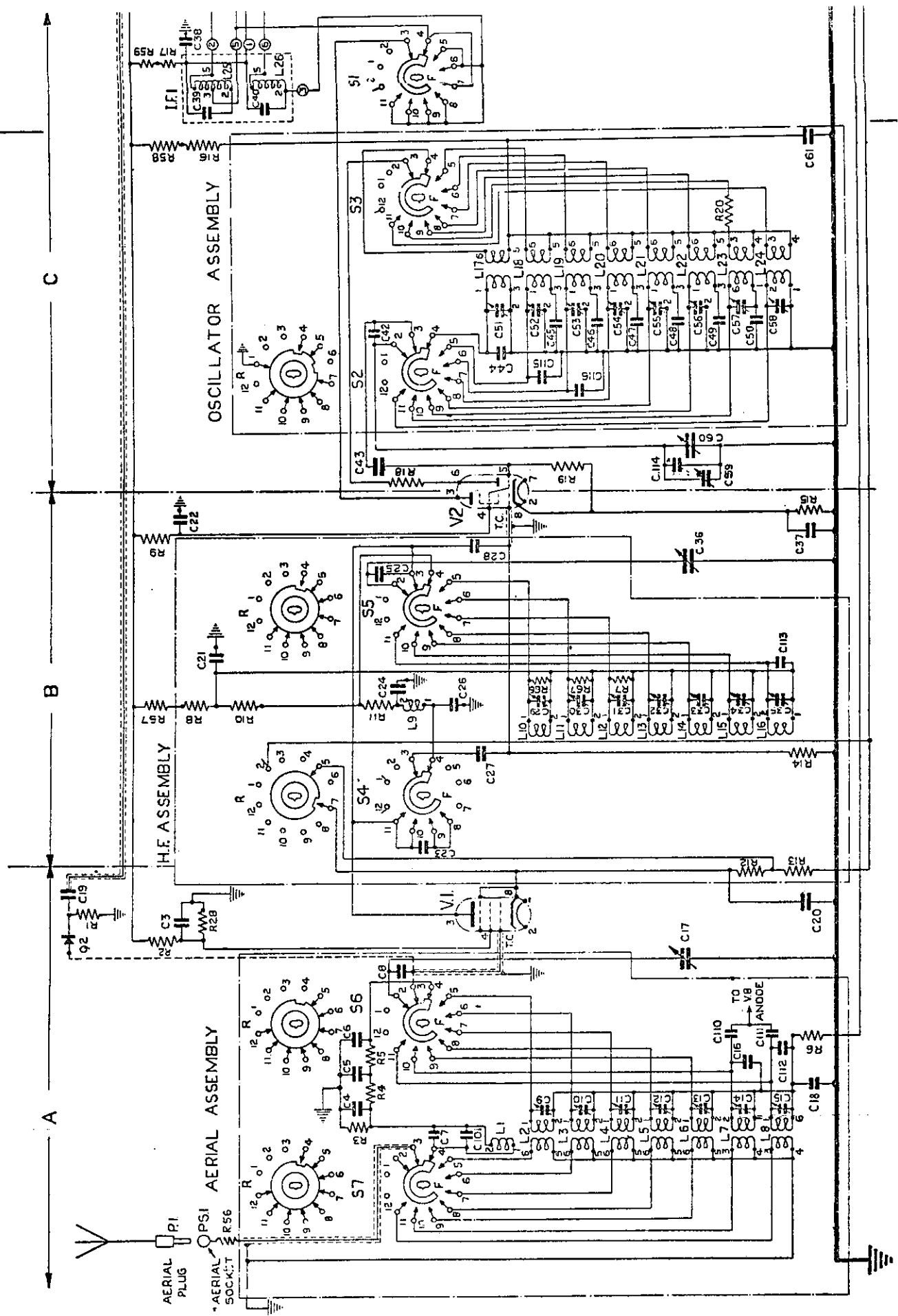

CIRCUIT DIAGRAM OF TYPE CR.300/1 AND CR.300/2 RECEIVER.

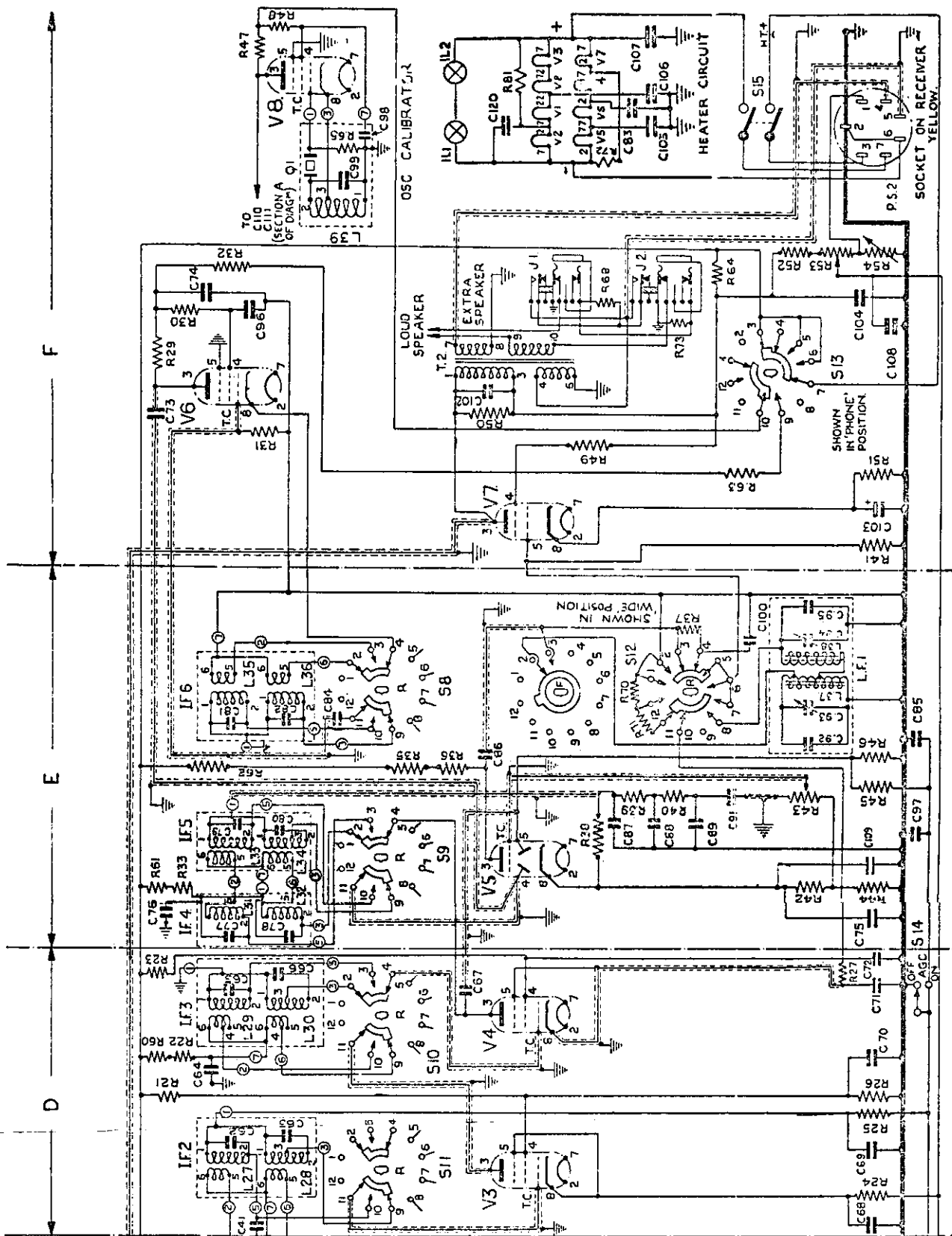

CIRCUIT DIAGRAM OF TYPE CR-300/1 AND CR-300/2 RECEIVER.

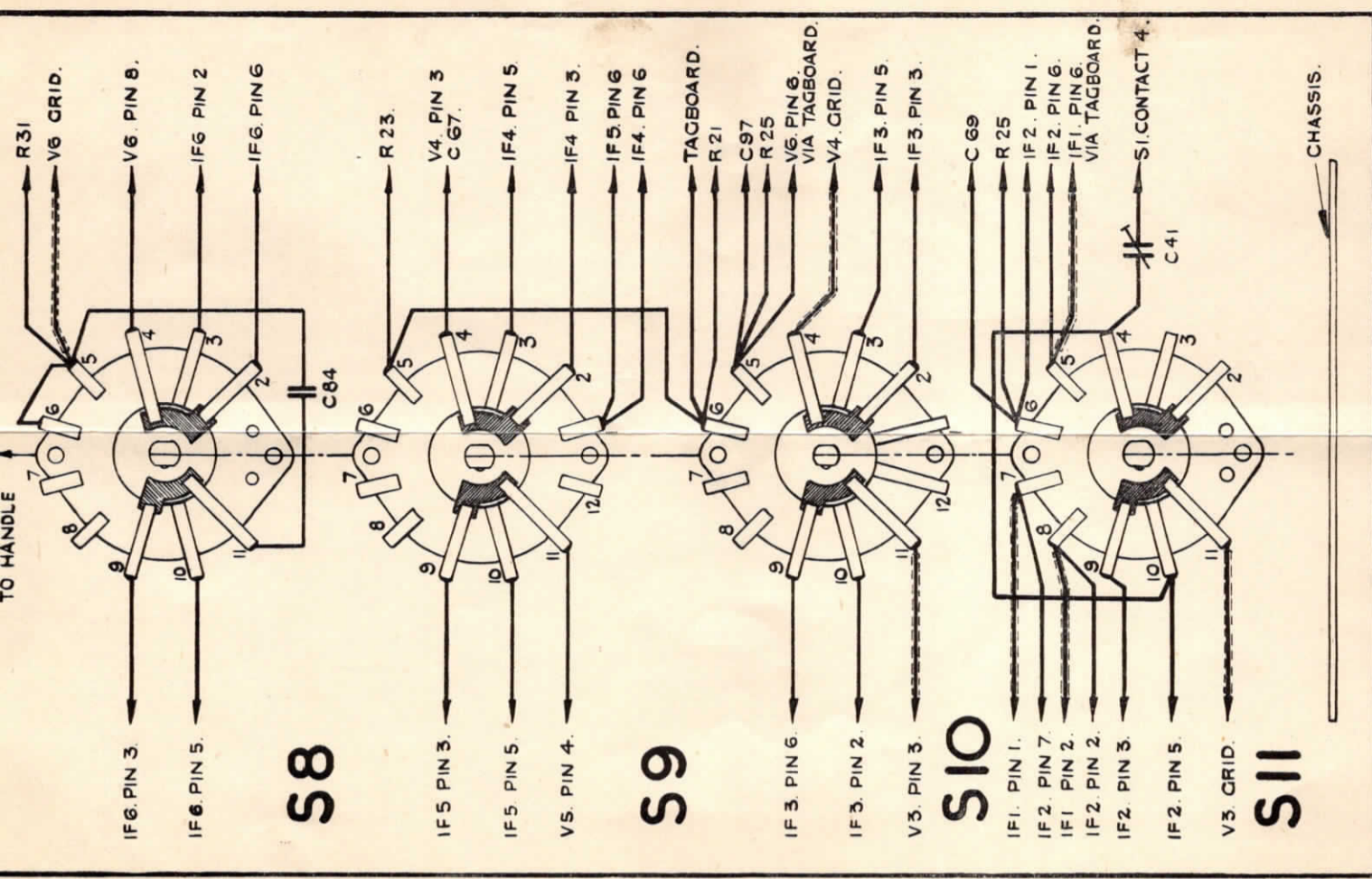
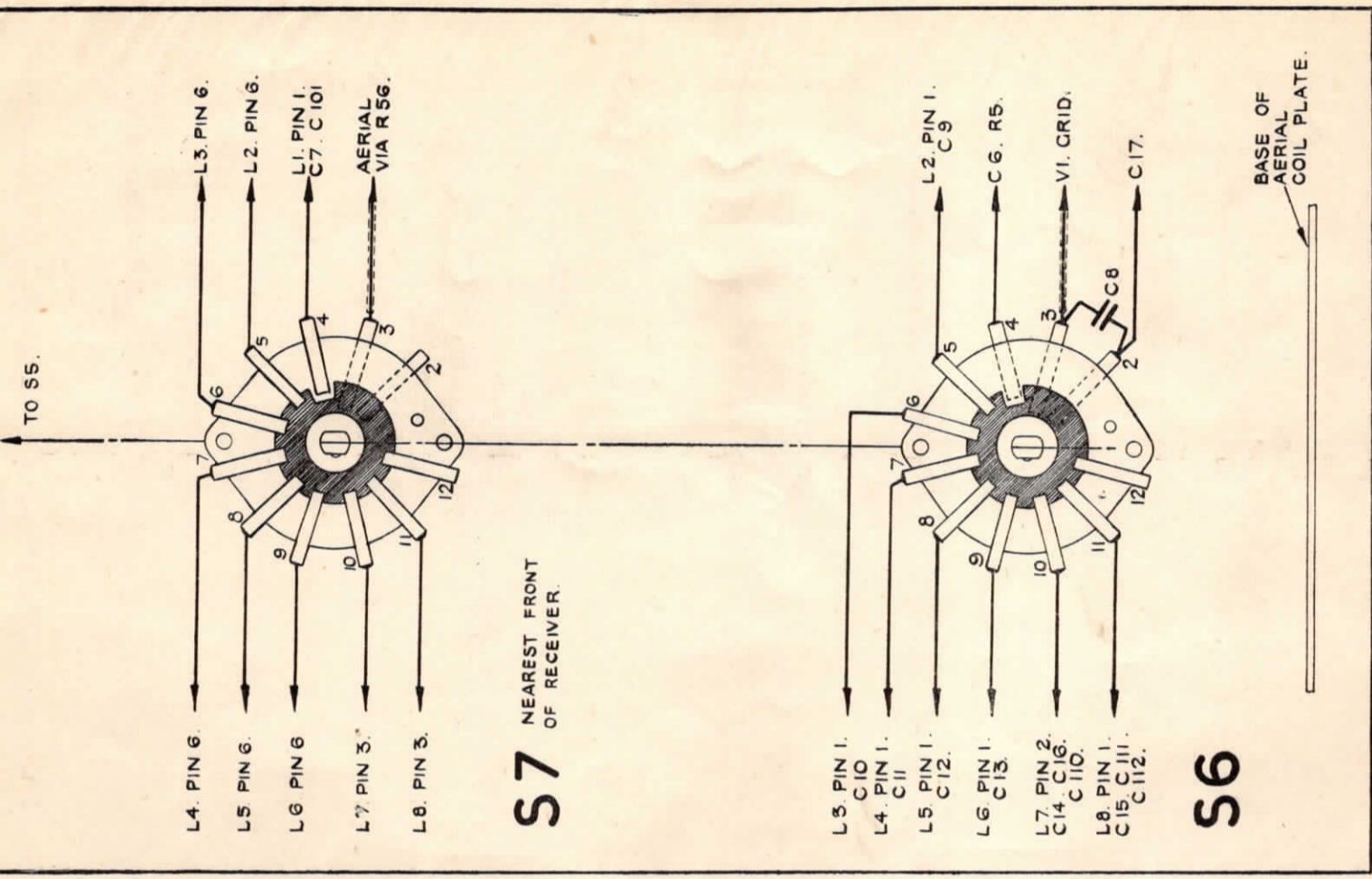
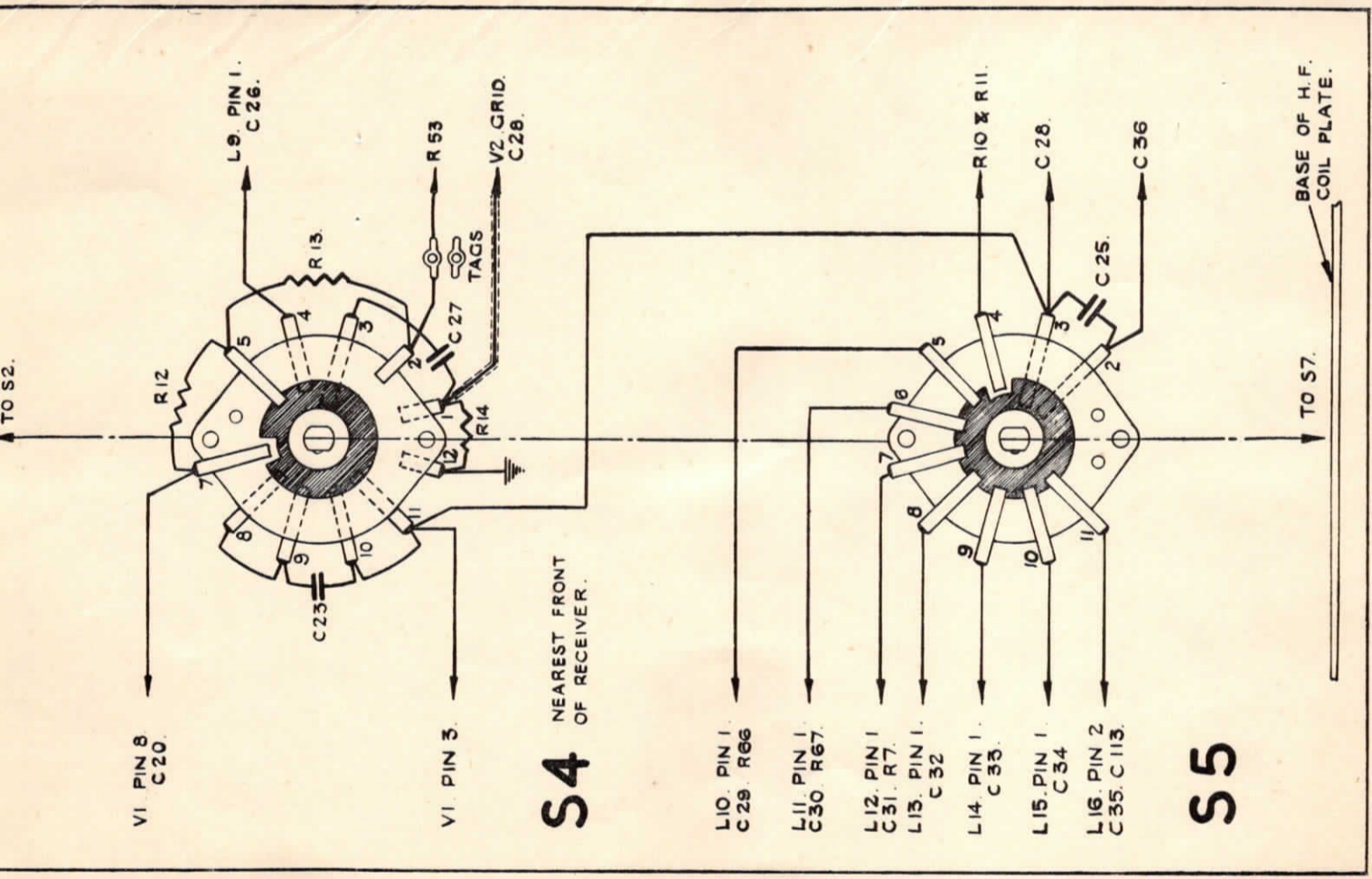

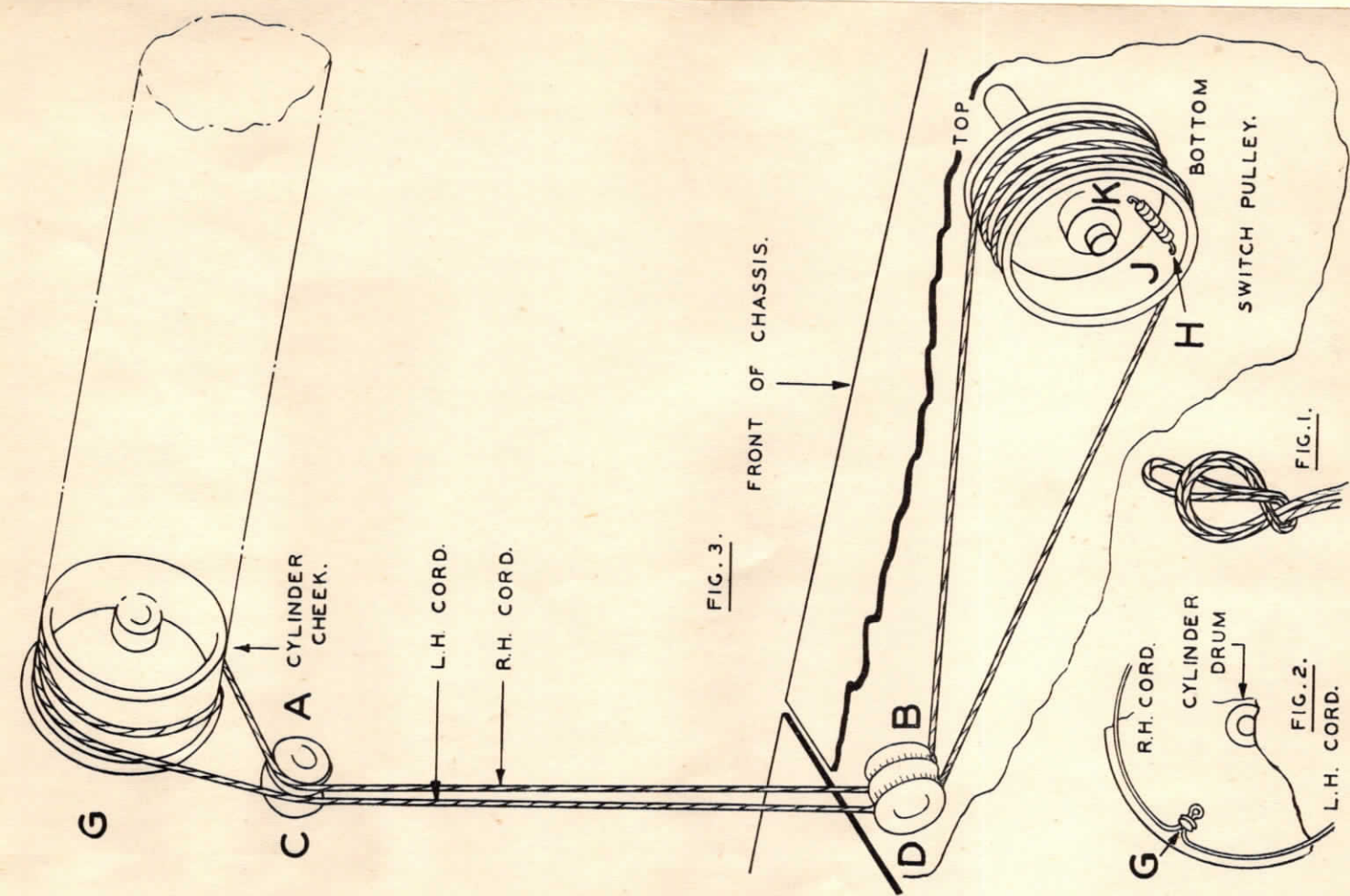

WZ. 1922/C. Sh. 1.  
METHOD OF FIXING RANGE DRUM ACTUATING CORD.

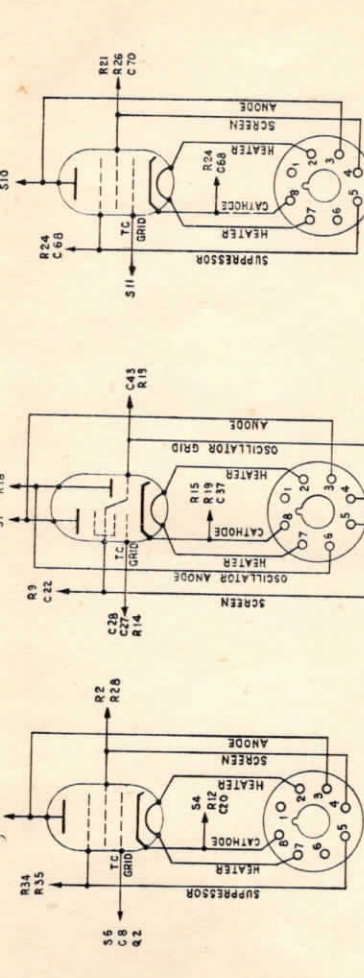

V.1  
KTW.61 (FOR CR.300g/2)  
OR  
ARTH. 2 (FOR CR.300g/1)  
VARIABLE-MU. HF. PENTODE.

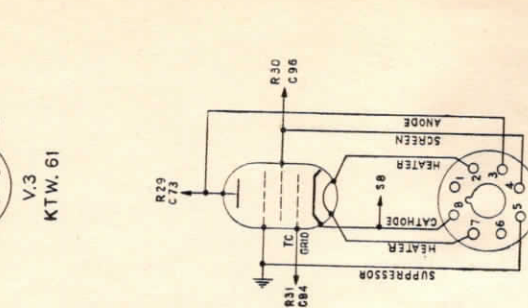

V.3  
KTW.61

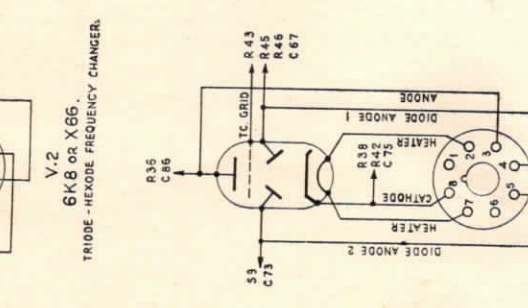

V.2  
6KB or X66.  
TRIODE-HEXODE FREQUENCY CHANGER.

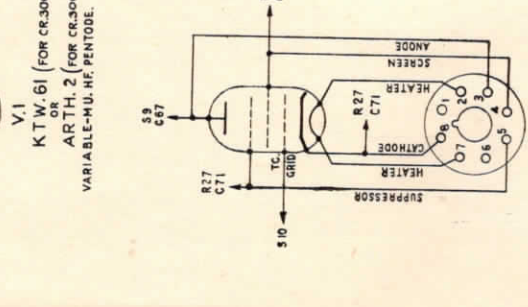

V.4  
KTW.61

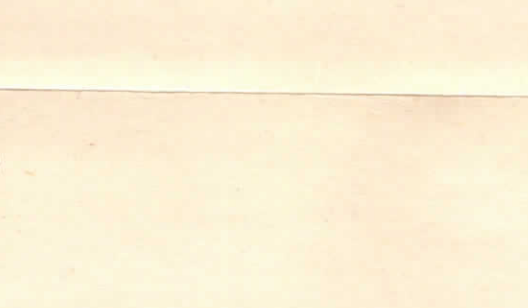

V.5  
DH.63  
DOUBLE DIODE-TRIODE.



V.6  
KTW.61

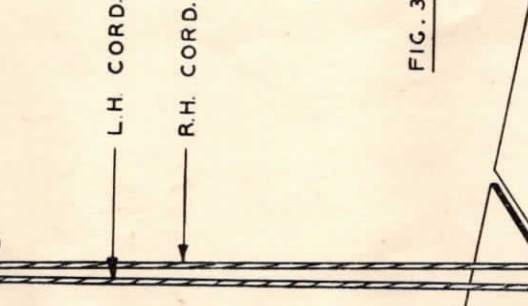

V.7.  
6V.6G.  
POWER PENTODE



V.8  
KTW.61  
ALL VALVE BASES ARE AS VIEWED FROM UNDERSIDE.



V.11  
0Z.4  
FULL-WAVE COLD CATHODE GAS RECTIFIER  
(ON TYPE B89 POWER SUPPLY UNIT.)

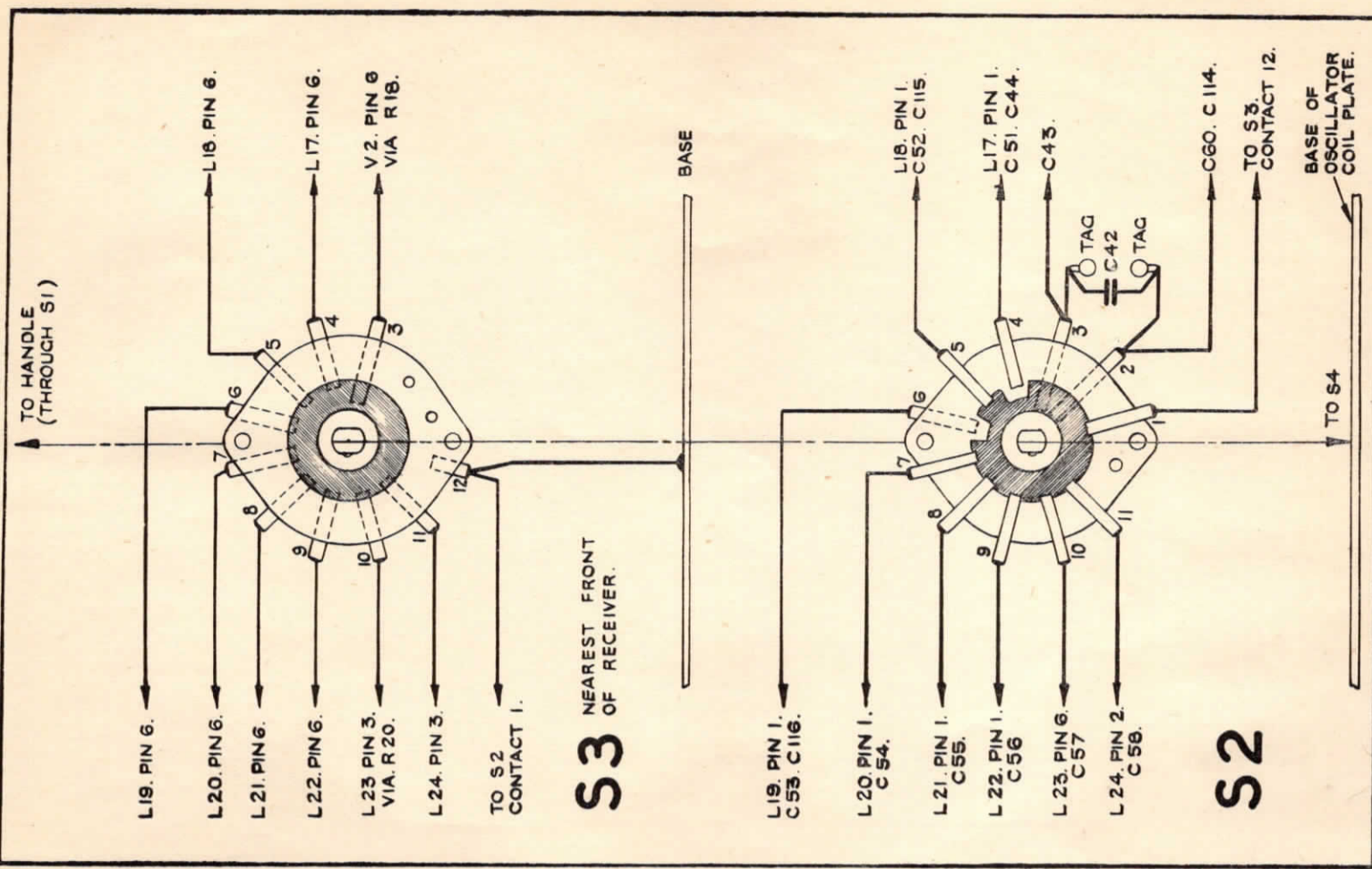
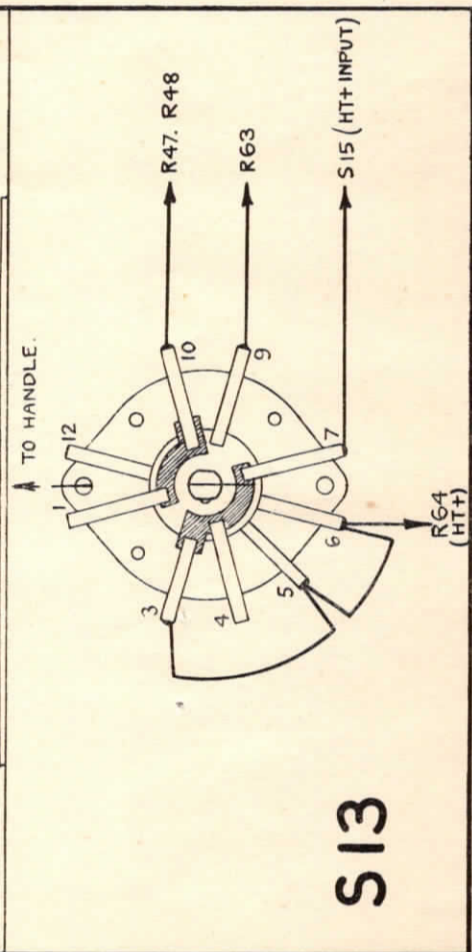
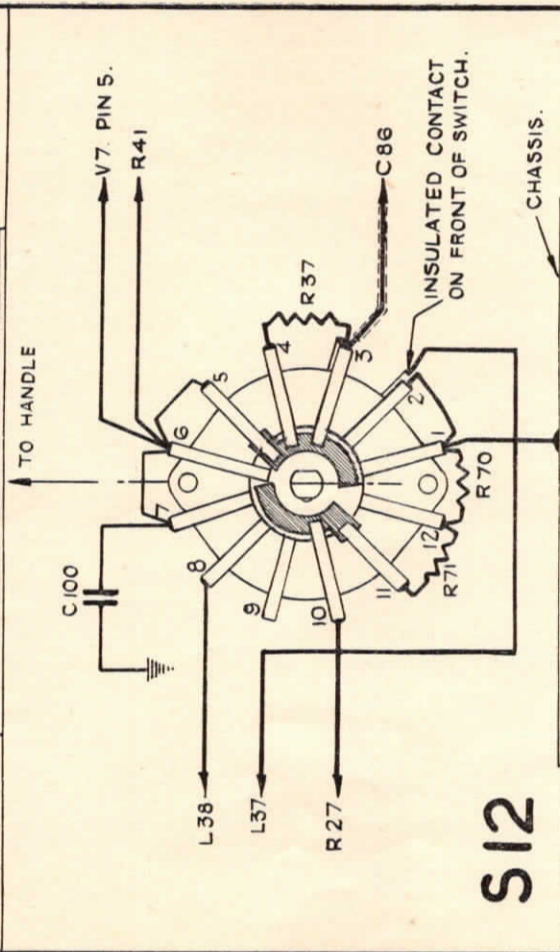
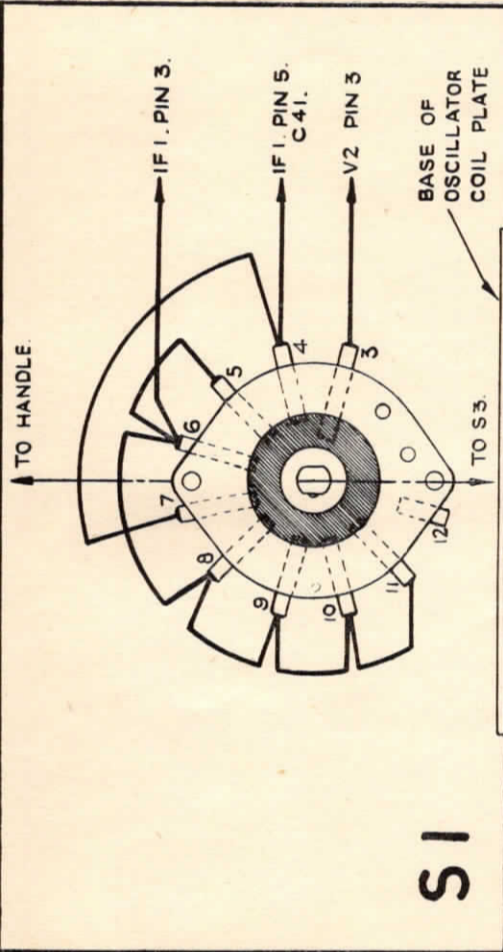



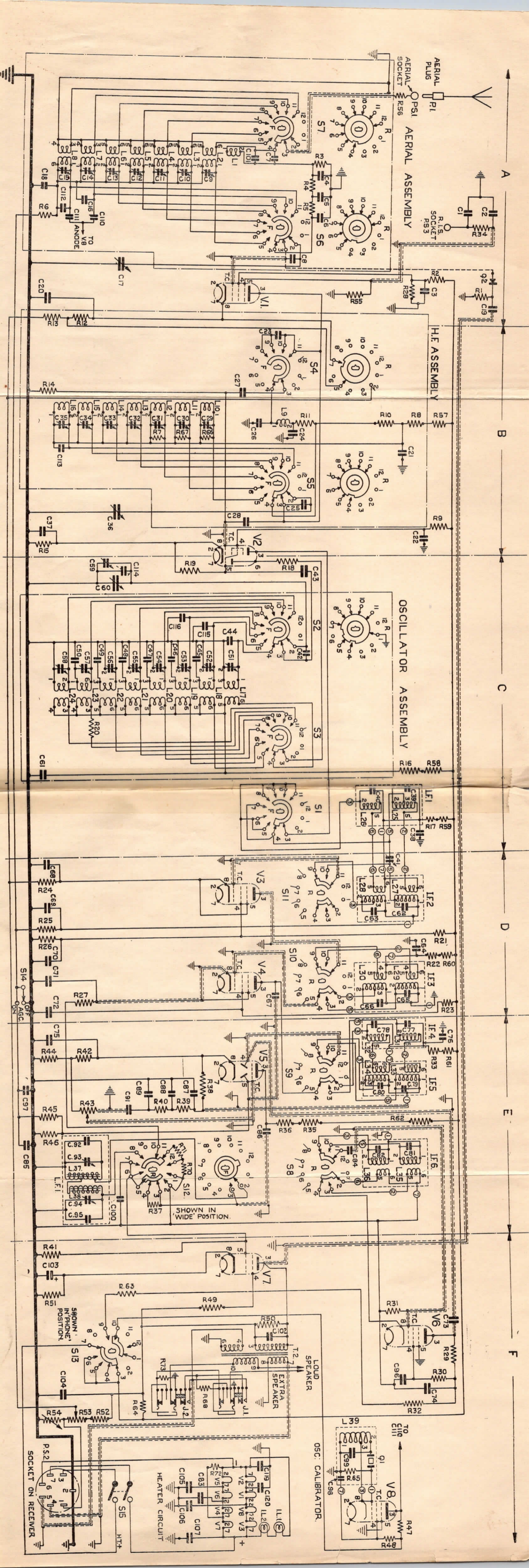



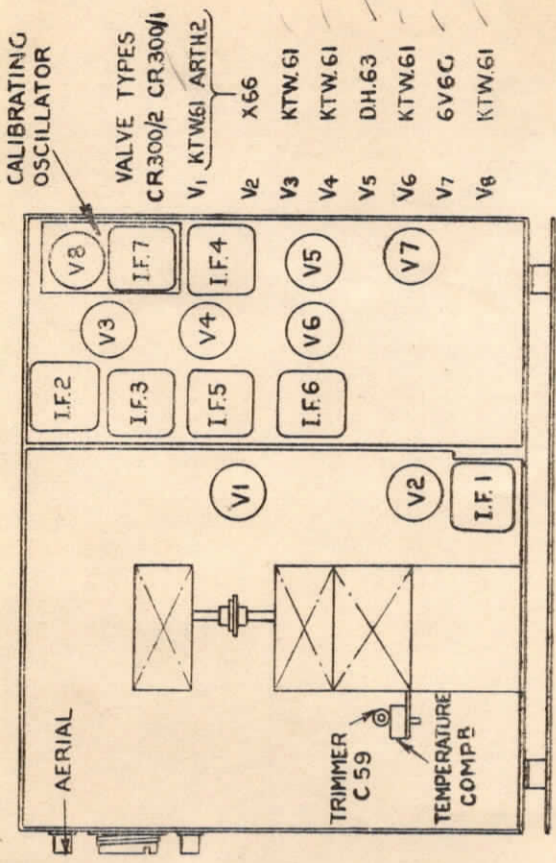
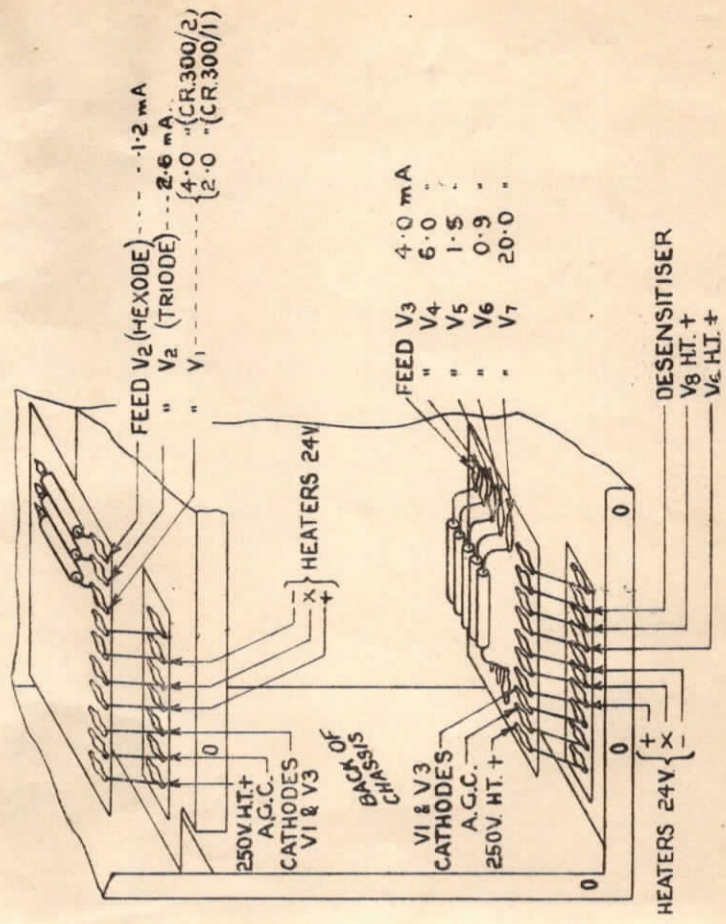

Fig. 6. Position of Valves in Receiver.



NOTE—In the CR.300/2 model the connection between the 3rd pair of tags from the right (V.8 H.T. +) is omitted.

Fig. 8. Checking Valve Feeds.

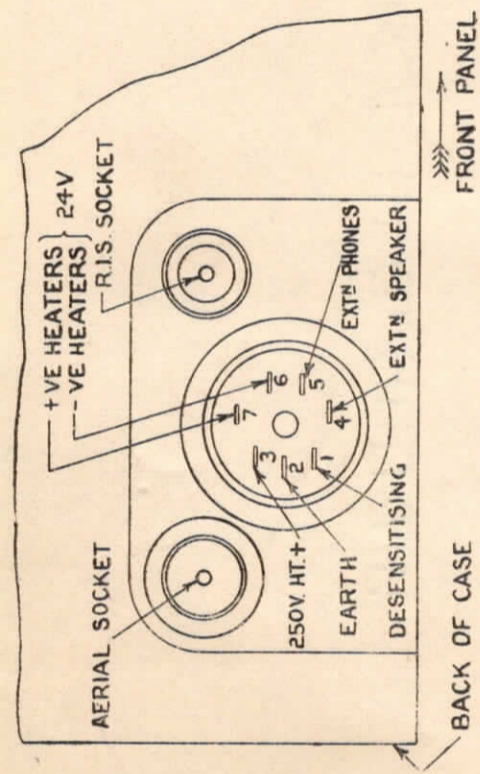

Fig. 5. Power Socket Connections.

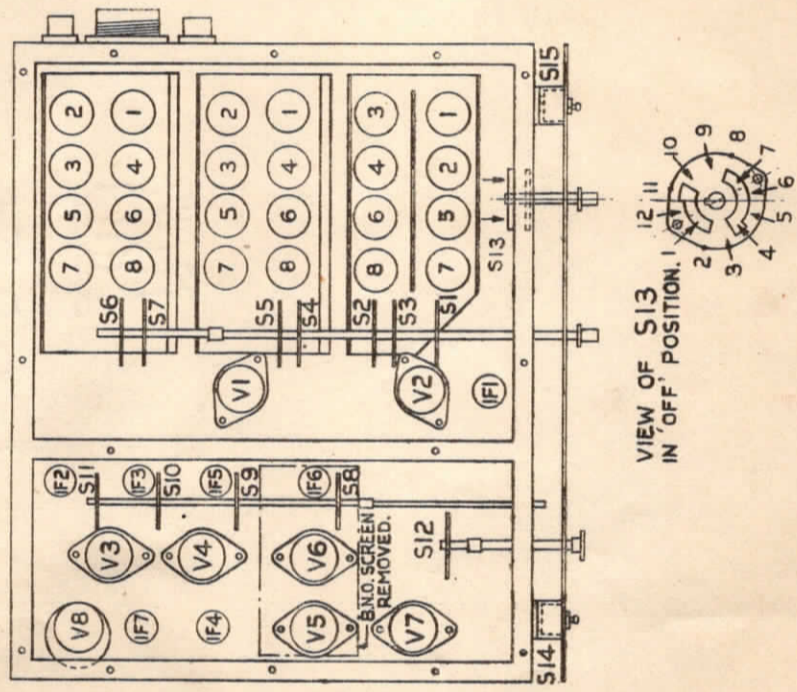

Fig. 7. Position of Switches.

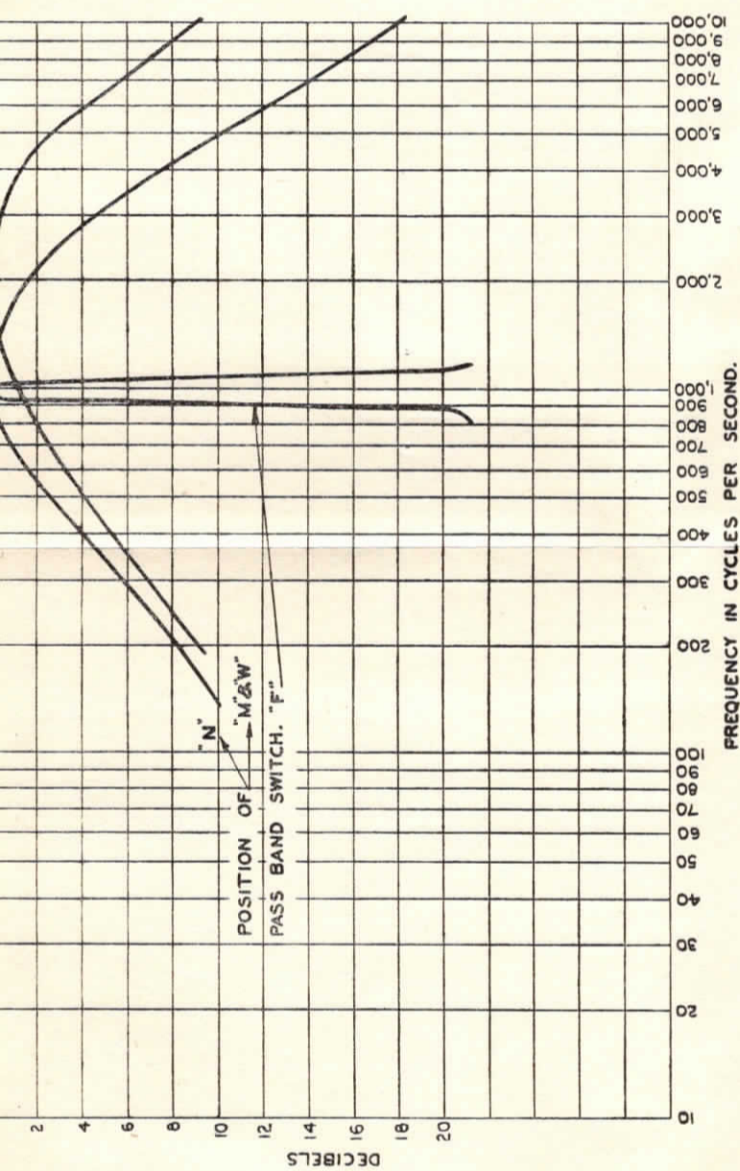

Fig. 1. Low Frequency Response Curves.

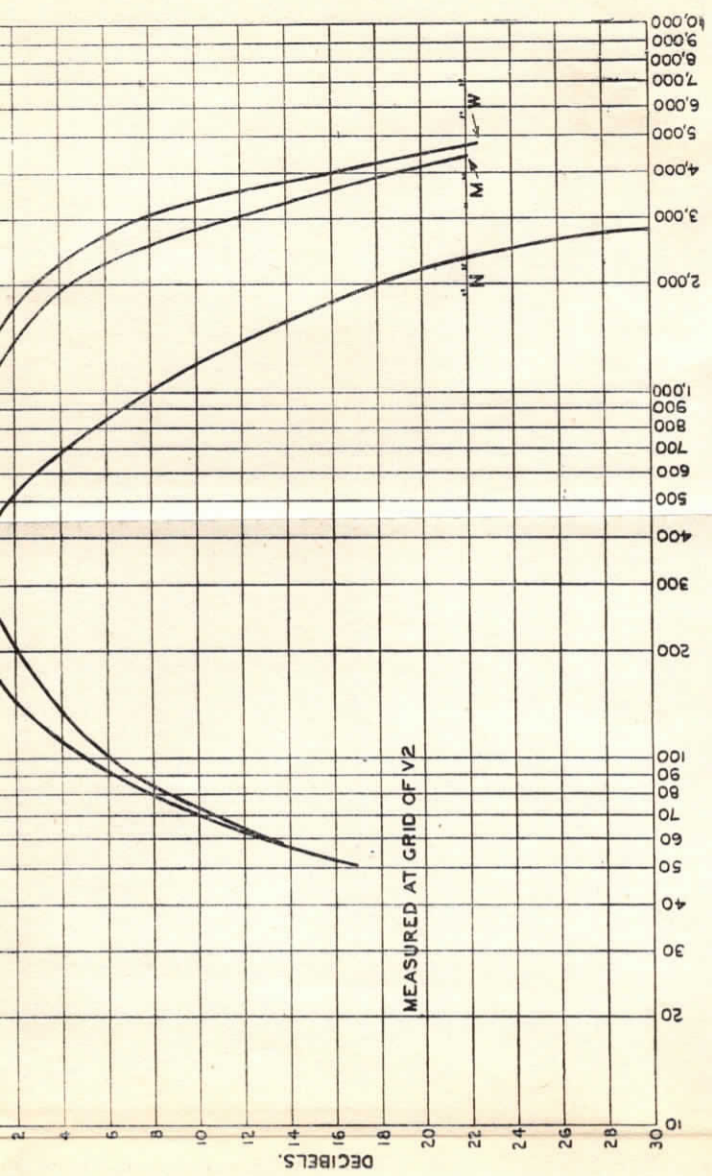
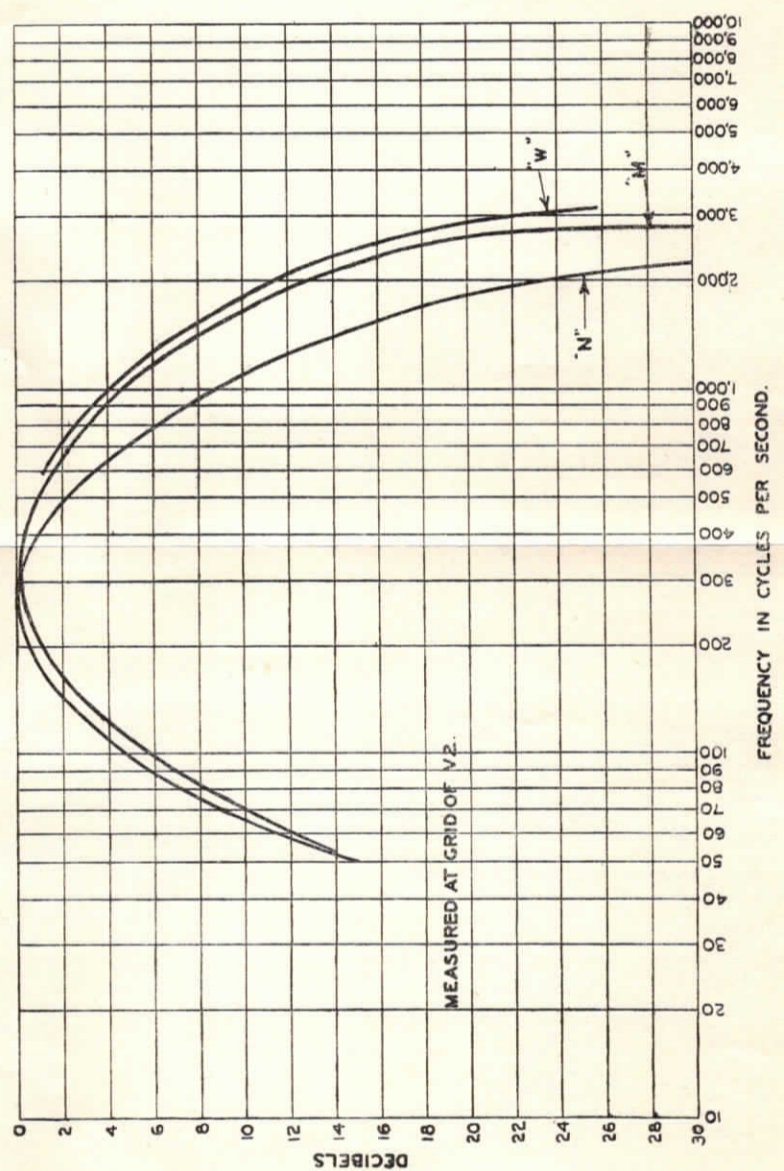
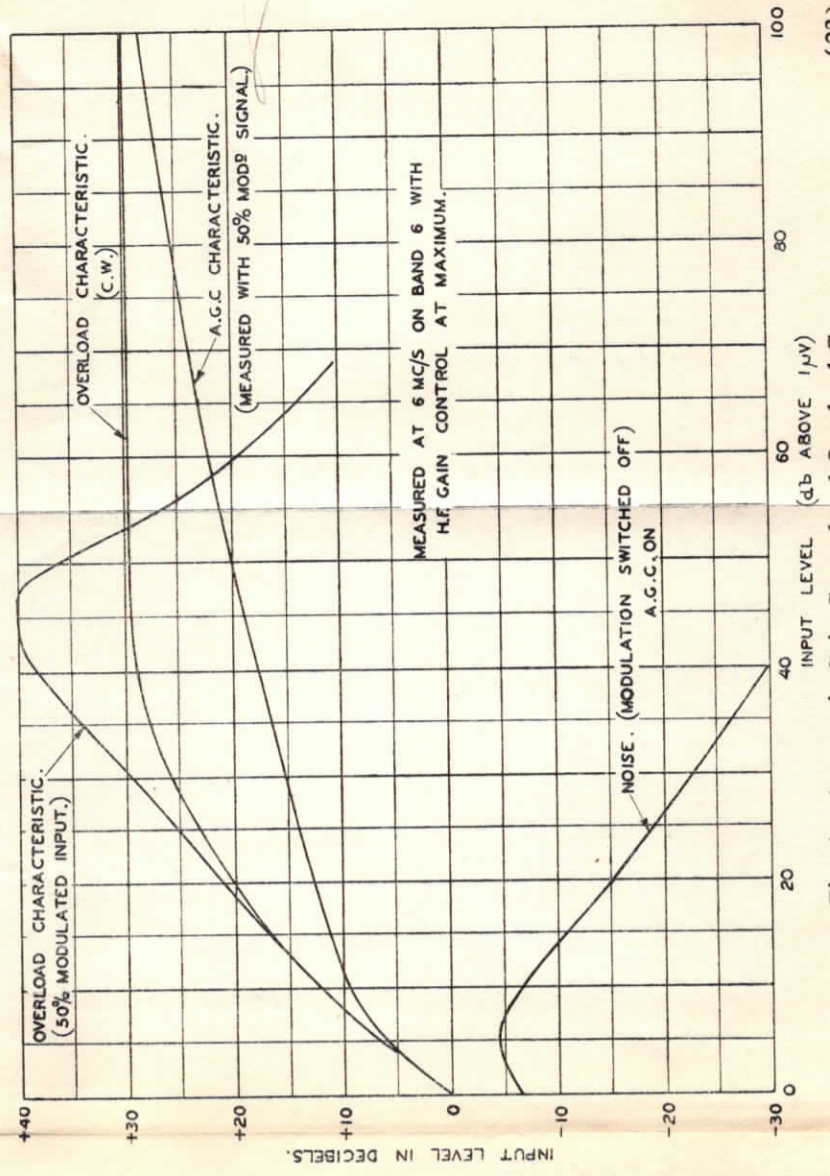
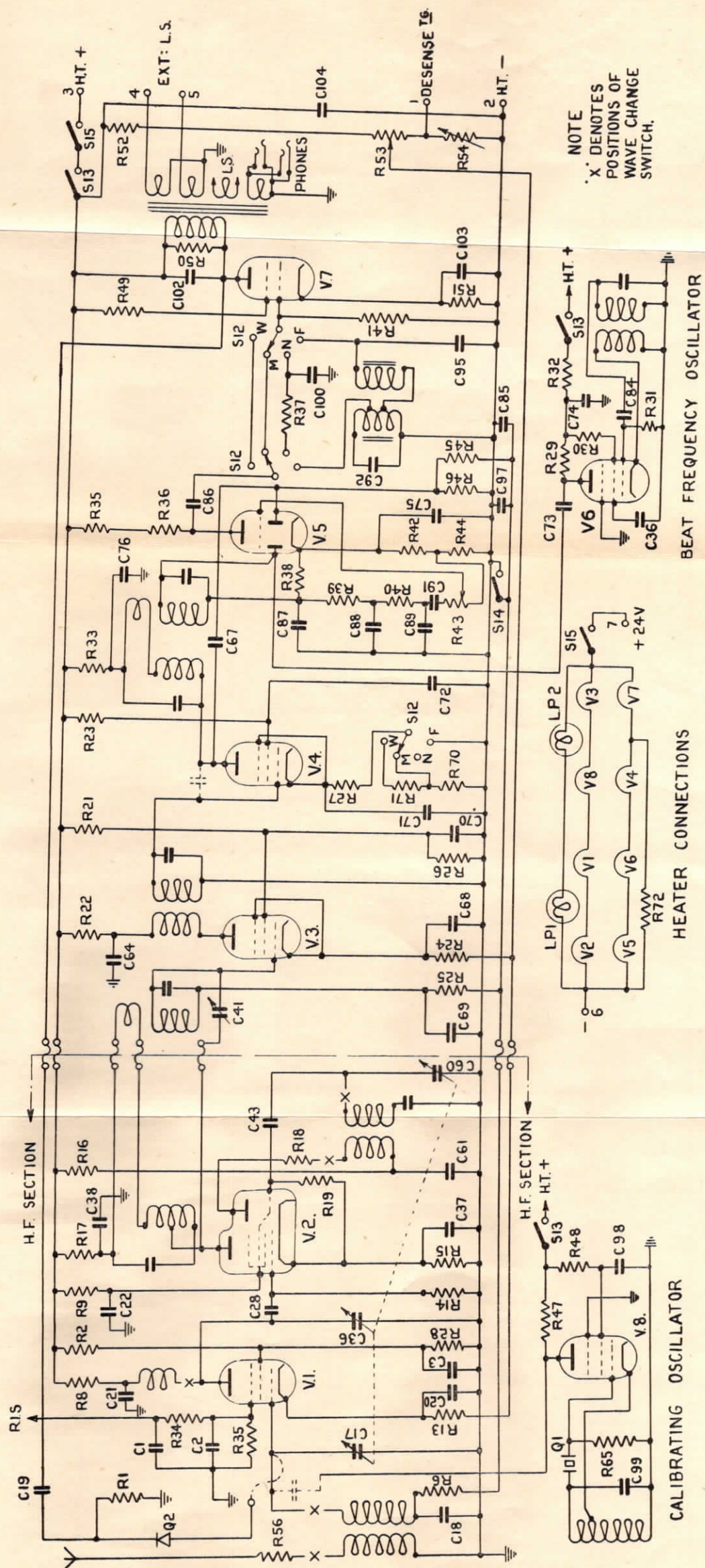

Fig. 3. Overall Response Curves (570 kc/s).





NOTE  
 'X' DENOTES  
 POSITIONS OF  
 WAVE CHANGE  
 SWITCH.

WZ. 1818. Sh. 1 (issue 2).

SIMPLIFIED CIRCUIT DIAGRAM OF TYPE CR. 300/1 AND CR. 300/2 RECEIVER.

